

CV Section EC Meeting
Sunday, October 20, 2019
2:00 – 4:00 pm
San Francisco Marriott Marquis
San Francisco, CA

Attendees

Officers:

Babu Welch, Chair

Adnan Siddiqui, Chair Elect

Henry Woo, Vice Chair Clemens

Schirmer, Secretary Adam Arthur,

Treasurer

Amin-Hanjani, Sepideh

Amar, Arun

Arthur, Adam

Bulsara, Ketan

Cockroft, Kevin

Ducruet, Andrew

Fraser, Justin

Garrett, Karen

Graffeo, Christopher

Griessenauer, Christoph

Grossberg, Jonathan

Hoh, Brian

Kellner, Chris

Levy, Elad

Lin, Ning

Mack, William

Mocco, J

Morcos, Jacques

Nakaji, Peter

Osburn, Josh

Russin, Jonathan

Schirmer, Clemens

Siddiqui, Adnan

Simon, Scott

Singer, Justin

Stroink, Ann

Tjoumakaris, Stavropoula

Waldau, Ben

Welch, Babu

Guest Attendees

Elad Levy (CNS)

Robert Heary (AANS)



American
Association of
Neurological
Surgeons

Cerebrovascular Section of the AANS/CNS – EC meeting update 10/20/2019



Meeting Began at 2:00pm

Guests: Dr. Levy on behalf of the CNS.

EL: I'm here as CNS Secretary and Chair of CNS Foundation. We do not compete with NREF, we support a different aspect. We'd like to thank the CV section for their gift of 250K, which is now earmarked for use by the section, it's up to .5 million dollars. . Right now there's only 400K left in matching funds. Tomorrow we're doing a fundraising ride at Soul Cycle, I hope to see some of you there.

CS: This is inline with our commitment as EC members to give, this is just another option

Meeting Agenda

Guests

Officer & Standing Committee Updates

Minutes from the CV Section AANS Meeting (Dr. Schirmer)
Treasurer's Report (Dr. Arthur)
Fundraising Committee (Dr. Arthur)
Membership Update (Dr. Tjoumakaris)
Nominating Committee (Dr. Mocco)
Bylaws/Rules & Regulations Committee (Dr. James)
Website Committee (Dr. Griessenauer)

Annual Meeting Updates

2019 CNS Meeting (Drs. Osun, Simon)
2020 AANS Meeting (Drs. Osun, Kellner)
2020 CV Sect/SNIS (Dr. Simon, Osun)
2020 ISC (Drs. Huang, Kim, and Ducruet)
Robert J. Dempsey, MD Cerebrovascular Resident Research Award (Dr. Baskaya)
CV Sect C. Gatch Research Award (Dr. David)
CV Traveling Fellowships (Drs. Arthur, Schirmer)
Dawson Medal (Dr. Zipfel)

Project Updates

CAS/Training Standards (Drs. Siddiqui, Day)
Philanthropy (Dr. Cockroft)
IAC-Carotid Stenting (Dr. Cockroft, Dr. Patel)
Cerebrovascular Coalition (Drs. Cockroft, Amin-Hanjani)
Brain Attack Coalition (Dr. Huang)
JC Technical Advisory Panel RE- CSC certification (Dr. Bambakidis)
Matrix and Milestones (Dr. Bambakidis)
CNS Education Division (Dr. Bambakidis)
DAISI (Dr. Siddiqui)
Washington Committee (Katie Orrico, Dr. Woo)
Coding & Reimbursement (Dr. Schirmer, Dr. Woo)
QOD (Dr. Connelly, Dr. Mocco)
JGC/CV Section Guidelines Committee (Dr. Welch)
MOC Vascular Module (Drs. Siddiqui)
SNIS update (Dr. Arthur)
SVIN Liaison (Dr. Jankowitz)
International Liaison (Dr. Niemela)
Newsletter Committee (Dr. Ducruet)
YNS Liaison (Dr. Howard)
Resident and fellow courses (Drs. Kellner, Binning, Arthur, Mascitelli)
3C meeting (Dr. Siddiqui)

New Business

Strategic Planning (Dr. Welch)



Cerebrovascular Section of the AANS/CNS – EC meeting update 10/20/2019



Congress of
Neurological
Surgeons

Minutes

DR. CLEMENS SCHIRMER

Any discussion about the minutes

Motion to approve: Arthur, second by Mocco, all in favor: Unanimous approval of the minutes



American Association of Neurological Surgeons



Congress of Neurological Surgeons

Treasurer's Report

DR. ADAM ARTHUR

We are solvent



American Association of Neurological Surgeons

AANS/CNS Cerebrovascular Section Statement of Financial Position For the Twelve Months Ending Sunday, June 30, 2019



CNS

	Current Year 6/30/2019	Prior Year 6/30/2018
Assets		
Checking & Short Term Investments	159,561	215,950
Accounts Receivable, net of Allowa... Uncollectible Accounts	143,932	23,338
Prepaid Expenses	0	385
Long-Term Investment Pool, at Mar...	979,697	892,275
Total Assets	1,283,190	1,131,949
Liabilities and Net Assets		
Liabilities		
Accounts Payable and Current Liab...	30,000	5,000
Deferred Dues	35,538	32,970
Total Liabilities	65,538	37,970
Net Assets		
Unrestricted	897,183	842,842
Unrestricted - Donaghy	64,601	62,206
Unrestricted - Galbraith	32,842	32,418
Unrestricted - Leussenhop	19,731	20,286
Unrestricted - Drake	10,085	9,711
Unrestricted - Yasargil Lectureship	69,537	66,959
Net Revenue (Expense)	123,673	59,557
Total Net Assets	1,217,652	1,093,979
Total Liabilities and Net Assets	1,283,190	1,131,949



American Association of Neurological Surgeons

Cerebrovascular Section of the AANS/CNS - EC meeting update 10/20/2019



American Association of Neurological Surgeons

AANS/CNS Cerebrovascular Section Statement of Activities For the Twelve Months Ending Sunday, June 30, 2019



CNS

	FY '16 Final	FY '17 Final	FY'18 Final	FY'19 Final	FY'19 Budget	FY '20 Budget
Revenues						
Membership Dues	60,160	61,388	64,164	66,133	60,500	62,000
Contributions/Sponsorships	32,500	15,000	40,293	30,000	45,000	40,000
AANS/CNS support Finance & Mem...	9,356	10,005	6,899	7,969	10,837	13,580
Training Course	0	6,000	0	100,200	0	0
Annual Meeting Revenue	381,135	338,330	304,142	395,558	360,000	180,000
Total Revenue and Support	483,152	430,723	415,498	599,859	476,337	295,580
Expenses						
Audio Visual	20,563	8,333	11,074	8,869	9,000	11,000
Bank Fee	1,324	1,254	1,318	824	1,300	1,300
Contributions & Affiliations	35,000	50,000	30,000	50,000	50,000	50,000
Food & Beverage	19,585	13,928	11,174	22,219	14,000	11,500
Honoria & Awards	42,717	35,651	46,777	41,299	45,000	45,000
Office & Other Supplies	55	7	53	100	0	0
Photocopy	0	0	0	5	0	0
Postage & Distribution	264	229	219	635	250	250
Printing/Typesetting	9	185	0	0	200	0
Newsletter Professional Fees	0	0	58	132	0	0
Website	14,120	11,822	1,260	4,135	4,800	3,500
Administrative Assistance	8	18,148	14,365	18,459	15,000	15,000
Telephone	95	8	1,114	0	0	1,000
Volunteer Travel	8,868	1,584	1,653	384	2,000	2,000
Tours/Transportation	1,410	1,515	232	0	1,500	1,000
Staff Coordination	10,344	10,391	7,416	7,983	12,075	13,637
Training Course Expense	0	0	0	42,702	0	0
Bad Debt Expense	0	0	0	1,595	0	0
Annual Meeting Expense	306,335	290,891	286,162	364,265	320,000	140,000
Total Expense	469,697	443,945	417,875	563,607	475,125	295,197
Investment Earnings	(4,999)	60,132	56,934	87,422	0	0
Net Excess (Loss)	17,456	46,910	59,557	123,673	1,212	393

These figures are in line with past years



American Association of Neurological Surgeons

Cerebrovascular Section of the AANS/CNS - EC meeting update 10/20/2019



Congress of Neurological Surgeons



THE NEUROSURGERY RESEARCH AND EDUCATION
FOUNDATION
Summary of CV Funds
6/30/2019

	FY16	FY17	FY18	FY19
Summary of CV Funds				
Charles Drake Fund	19,884	22,266	24,309	25,245
CV Traveling Fellowship		303,390	313,106	363,385
CV Research Lectureship			60,351	81,703
Warren R. Selman			3,562	6,802
*Research CV	163,911	139,202	98,654	75,297
*Outcome CV			639	1,173
*Education CV			29,646	52,931
Total of CV Funds	183,795	464,858	530,267	606,536

*These funds are controlled by NREF

Adam Arthur: As Clemens mentioned, we want to promote philanthropy. What I have here are our section funds under NREF. We've undertaken a major initiative with the CNS foundation, and we're eager to utilize their funds. I have a list of those who have contributed to NREF, but not the other two organizations. In Boston I will be showing a list of all donors to all three foundations. I urge all CV members to give to at least one of those organizations, we're really going to be doing a lot with those funds. We're grateful to all of you who are supporting our mission.

Please do make donations

We have all of these awards, which are fully funded

Current Awards

- Drake lecture- \$1000
- Galbraith lecture- \$1000
- Yasargil lecture- \$1000
- Donaghy lecture- \$1000
- Lussenhop lecture- \$1000
- Hopkins lecture- \$1000
- Dacey lecture- \$1000
- Resident research award- \$500 (one each at CNS and AANS meeting)
- Resident clinical award- \$500 (one each at CNS and AANS meeting)
- Dempsey research awards- Two at \$15,000 each

Fundraising Committee

Members: Arthur, Cockroft, Mocco, Nakaji, Siddiqui, Zipfel

Goals:

- Create culture of philanthropy for the benefit of the Section
- Report on annual giving to the Section
- Encourage 100% participation by Section Officers, EC members and the broader membership of the Section



THE NEUROSURGERY RESEARCH AND EDUCATION
FOUNDATION
Summary of CV Funds
6/30/2019

	FY16	FY17	FY18	FY19
Summary of CV Funds				
Charles Drake Fund	19,884	22,266	24,309	25,245
CV Traveling Fellowship		303,390	313,106	363,385
CV Research Lectureship			60,351	81,703
Warren R. Selman			3,562	6,802
*Research CV	163,911	139,202	98,654	75,297
*Outcome CV			639	1,173
*Education CV			29,646	52,931
Total of CV Funds	183,795	464,858	530,267	606,536

*These funds are controlled by NREF

Nominating Committee Report

Dr. J Mocco

-Verbal Report

J Mocco: nominating committee will start early discussions now, if anyone is interested in any offices please send me an email



Cerebrovascular Section of the AANS/CNS – EC meeting update 10/20/2019



Membership Update

Dr. Stavroupoula Tjoumakaris

CV Section Membership Statistics, as of 9/30/2019

Member Class	Subclass	2019 Dues	2019 Members	2018 Members	2017 Members	2016 Members
Active	01S	\$150	430	395	389	382
Adjunct/Associate	60D	\$100	59	40	40	43
International	40S	\$50	81	67	65	60
Lifetime/Senior	20S	\$0	107	110	108	105
Medical Student	15M	\$0	14	18	20	33
Resident	50R	\$0	1,917	1,827	1,676	1,528



Cerebrovascular Section of the AANS/CNS – EC meeting update 10/20/2019



We're staying with a continuous increase in membership. We have the highest active and international increase in membership, 10% active, 20% international increase. We're also almost reaching 2K resident members, so I urge you all to go back and encourage residents, fellows, and others to join the section.

NEW MEMBERS		
Active	Resident	
Eric Sandoval, MD, FAANS	Navodhya Kumar Jindal, MSMCh	
Gunjan Goel, MD	Ioana Rusu, MD	
Stephan Munich, MD	Javier Saavedra, MD	
Jonathon Lebovitz, MD	Achal Gupta, MBBS, DNB	
Juan José Martín, MD, FAANS	Jakub Šobón, MD	
Khaled M. Krisht, MD, FAANS	Julian Leonardo Gallo Rodriguez, MD	
Christoph Johannes Gnessenauer, MD, FAANS	Angelo Tavani, MD	
Eric J. Arias, MD	Fitra Fitra, MD, M. Med.Sc	
David K. Kung, MD	Giovanni Barbagli, MD	
Evan Seth Marlin, MD	Berta Freixer Palau, MD	
	Syed Sarmad Bukhari, MBBS	
Adjunct Associate	International	
Zachary A Hitchcock, PA-C	Oleg D. Shekhtman, MD PhD	
Nicole Marie Moler, ACNP-BC	Eric Misael Estrada Estrada, MD	
Kevin Watson, PA-C	Jose A. Fernandez Alen, MD, PhD, IFAANS	
Laura Skanse, PA-C	Rajesh Parameshwaran Nair, MBBS, MCh	
Lindsey Buehrer, NP-BC		
Amanda T. Wuebben, FNP-BC		
Robin McLawhorn, NP		
Afsaneh Faramarzi, NP		
CV Section 2019 Dues Notice Mailings		
1st Notice	Emailed	2/26/2019
2nd Notice	US Mail	4/29/2019
3rd Notice	Emailed	7/12/2019
4th Notice	US Mail	9/13/2019

Cerebrovascular Section of the AANS/CNS – EC meeting update 10/20/2019

These are new active and international members.

CV Section Report, FALL 2019	
Members with 2 years outstanding dues. Reminders sent 9/13/2019	
John M. Abrahams, MD, FAANS	Christopher M. Loftus, MD, FAANS, FACS
Alex Alfieri, MD, PhD, IFAANS	Jaime Teobaldo Lopez Calle, MD
Ismail H. Aydin, MD, IFAANS	Murat Ulutas, MD PhD
Estrada J. Bernard, Jr., MD, FAANS	Angel Nickolov Boev, MD, FAANS
Hana Choe, MD	Jean-Louis R. Caron, MD, FAANS, FACS
Mark Joseph Dannenbaum, MD, FAANS	Thomas B. Falloon, MD, FAANS
Gazi Muhammad Zeeshan Dow, MD	Timo S. Koivisto, MD, PhD
Moneeb Ehtesham, MD	David W. Newell, MD, FAANS
Shoichiro Kawaguchi, MD, IFAANS	Aman B. Patel, MD, FAANS
Louis L. Kralick, MD, FAANS	Hirotooshi Sano, MD, IFAANS
Stephen B. Lewis, MBBS, IFAANS, FRCS	Daniel A. Wecht, MD, FAANS

Cerebrovascular Section of the AANS/CNS – EC meeting update 10/20/2019

Clemens Schirmer: We're going to take a slight detour from the agenda, we have a guest joining us, Dr. Robert Heary, on behalf of the AANS.

Dr. Heary:

In response with sections coming to AANS asking for help with Strategic planning, we are organizing a strategic planning forum, in conjunction with our BOD meeting in November. We ask all chair's ,or someone in a high position within the section, to attend, as we'll be offering guidance in strategic panning. I think the CV section is overall strong, but the AANS is trying to be helpful and offering assistance.

In addition, in Spring, there's a Sonntag symposium honoring Volker Sonntag, we're asking as many as possible to attend the Sonntag symposium.

Last, I saw Dr. Arthur giving NREF updates, one additional point, the traveling prize you do is great, I think others may follow in your footsteps. The Honor Your Mentor funds, in order to use those you have to collect 50K. Once that amount is collected monies can then be dispersed. The downside is you only have 5 years from when a fund starts to collect the 50K, which gets a little confusing. Hopefully we'll get them all up to the 50K and start using that money.

Jacques Morcos: Just to remind you all that I am the assigned Director of Large Division 5. I'm in charge of all the sections in the sense of communicating any needs of the section to the AANS. In the past there was some disconnect between parent organizations and sections, so I'm in that position for all 3 years I'm on the board.

Bylaws & Rules & Regulations Committee

Dr. Robert F. James (Chair)

Dr. Stacey Wolfe

Dr. Alex Spiotta

-No Report



Website Committee

Thank you **Jonathan Russin** for your work as website committee chair

- New chair: Christoph Griessenauer
- News/Social Media: Justin Singer, Ning Lin, Joey Linzey
- Patients: Peter Kan
- Members: Aditya Pandey, Chris Roark, Rabih Tawk
- Meetings: Rose Du
- Education: Justin Mascitelli, Daniel Heiferman
- Awards and Grants: Scott Simon
- Research: Scott Simon, Josh Osbun
- International: Leonardo Rangel-Castilla



Website Committee

Contract with vividites
- No outstanding invoices



Website Committee

CV Section website visitors behavior

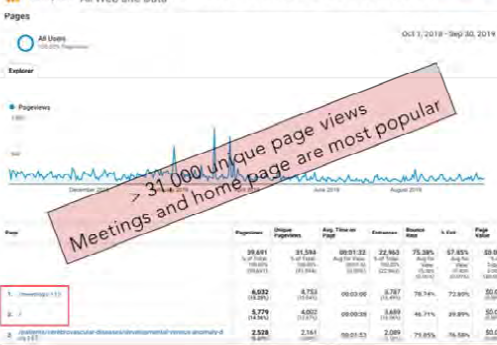

We have 31K unique website views

Most coming in through organic search, meaning search engines

Website Committee

Analytics All Web Site Data



Website Committee

Updates to the home CV section page

Embedded CV section newsletter pdf on home **PDF Embedder**

[Home](#) [News](#) CV Section Newsletter

CV Section Newsletter

Current Newsletter
[Winter 2019 CV section newsletter](#)

Available Newsletters from the Archive

[2011](#) [2012](#) [2013](#) [2014-1](#) [2015-1](#) [2016-1](#) [2017](#)
[2001](#) [2002](#) [2003](#) [2004](#) [2005](#) [2006](#)
[1995](#) [1996](#)



RECENT POSTS

RECENT COMMENTS

ARCHIVES

CATEGORIES

META



Cerebrovascular Section of the AANS/CNS – EC meeting update 10/20/2019



Also include an updated editing tool

Website Committee

Updated CMS editing tool

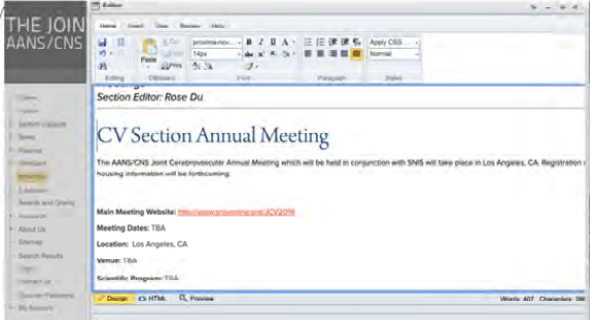

Section Editor: Rose Du

CV Section Annual Meeting

The AANS/CNS Joint Cerebrovascular Annual Meeting which will be held in conjunction with SWS will take place in Los Angeles, CA. Registration and housing information will be forthcoming.

Main Meeting Website: [http://www.aans.org/EC/2019](#)

Meeting Dates: TBA

Location: Los Angeles, CA

Venue: TBA

Scientific Program: TBA



Cerebrovascular Section of the AANS/CNS – EC meeting update 10/20/2019



Website Committee

Vividsites quote to refresh website design and implement requested updates

- \$1,200/month (2 year minimum)
- Security patches to plug vulnerabilities
- Bug fixes and patches for browser upgrades
- Plugin software updates
- On demand updates
- Testing and deployment on a staging server
- Staging website hosting for presenting and testing before pushing live
- Testing and deployment on live server
- Phone and email support

This quote is for 2 years, including all updates plus maintenance.



Cerebrovascular Section of the AANS/CNS – EC meeting update 10/20/2019



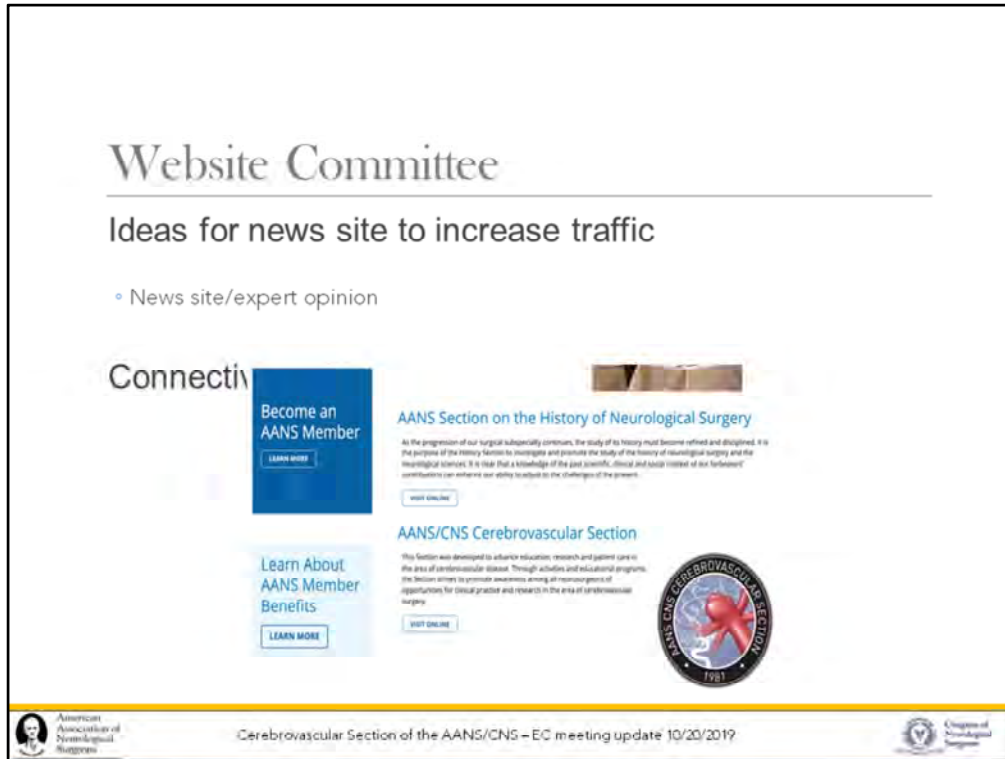

The more connected we are with other sites, the higher we are ranked on search engines

If any of you can think of sites who can link to us, that would certainly help us in that regard. I'd be happy to provide that site's admin our link and logo

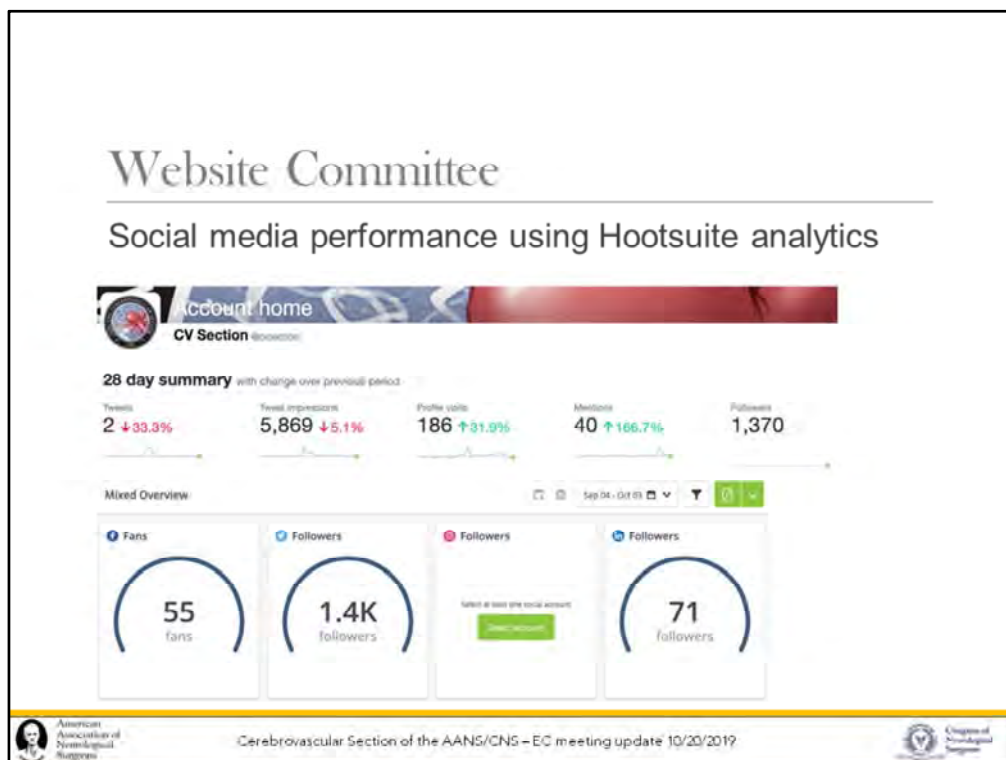

We have over 1400 followers



American Association of Neurological Surgeons



Congress of Neurological Surgeons

Annual Meeting Updates

2019 CNS Meeting- Simon/Osbun/Kellner

Symposium

- Advanced Techniques in the Treatment of Intracranial Aneurysms

Courses

- A New Era in Stenting
- Bypass Techniques in Cerebrovascular Surgery
- Implementation and Management of Community Stroke Networks and Thrombectomy Centers

Dinner Seminar

- Multi-modality AVM treatment in the past, present, and future

Interactive

- Treatment of Cerebral aneurysms
- Treatment of Cerebral AVM/dAVF

Our program has been set for while Tuesday is on aneurysms



Cerebrovascular Section of the AANS/CNS – EC meeting update 10/20/2019

2019 CNS Meeting

Section Session Non-abstract time (45 minutes each):

- Future Training of the Cerebrovascular Neurosurgeon
- Artificial Intelligence in Cerebrovascular Neurosurgery

Guidelines/Sunrise

- Cerebrovascular Guidelines
- How to build a multi-disciplinary cerebrovascular team

The slide was reviewed



Cerebrovascular Section of the AANS/CNS – EC meeting update 10/20/2019



2019 CNS Meeting

Lunches

- Is Intracerebral Hemorrhage a Surgical Disease?
- Contemporary and Practical Management of an Enigmatic Process: Cerebral Vasospasm (Delayed Cerebral Ischemia)
- Venous stenting for Pseudotumor
- Carotid Artery Disease: Symptomatic/Asymptomatic/Stent/CEA
- Implementation and Management of Community Stroke Networks and Thrombectomy Centers
- Device Development in Cerebrovascular Neurosurgery
- Middle meningeal artery embolization for subdural hematoma treatment

2019 AANS Meeting- Osbun/Kellner

Monday

- Yasargil Lecture: Dr. Hunt Batjer
- Open Lecture: Dr. J Mocco
- Abstracts/Rapid Fire Abstracts

Tuesday

- Donaghy Lecture: Dr. Mika Niemela
- Abstracts/Rapid Fire Abstracts
- Point/Counterpoint: Treatment of Unruptured MCA Aneurysms

Popular topics from the past plus some new ones

We have some lectures set now for AANS Tuesday we have the lecture with Mika Niemela

2020 Joint CV Section Annual Meeting

August 3-4 in conjunction with SNIS

Marriott Marquis San Diego Marina, San Diego, CA

SNIS Co-chairs

Sandra Narayan
Reade DeLeacy

Babu Welch: there's been a lot of moving around in discussions about the Joint meeting. The meeting will now take place in Conjunction with SNIS August 4th-7th in San Diego. This came about as a result of our survey. We did all reach out to SVIN, and decided not to do any kind of merging with them, we were just waiting on the parent organizations to finalize everything.

The Meeting will be co-branded, we're going to be the only CV Surgeons there.

J Mocco: I just have two things. First, in terms of showing up strong, this is an environment for us to show the value neurosurgery as a whole bring to this space. If we're able to show up in force, I think that will end up strengthening neurosurgery positions. Second, the MOU is very pro-growth. There's increasing opportunity for the section to grow economically, we're not an afterthought, we're an integral part of the growth for the future. It's been a really great meeting planning area lately.

Scott Simon: I reached out to the SNIS co-chairs and they wanted to wait until the ink was on the contract before working on this with them.

Robert J. Dempsey, MD Cerebrovascular Research Award 2018-2019 Annual Update

Mustafa K. Baskaya, MD, Chair

Director of Skull Base Surgery

Professor of Neurological Surgery

Cerebrovascular and Skull Base Surgery

University of Wisconsin, Department of Neurological Surgery



Cerebrovascular Section of the AANS/CNS – EC meeting update 10/20/2019



Cerebrovascular Section of the American Association of Neurological Surgeons and The Congress of Neurological Surgeons once again awarded two \$15,000 Resident Research Awards in Cerebrovascular Disease in 2018-19.

Of the outstanding applications, winners of this award for 2018-19 are:

Christopher Young, MD from the University of Washington with his project, “Elucidating the molecular basis of endothelial dysfunction in intracranial aneurysms.”

Stephanie Chen, MD from University of Miami with her project, “Inflammatory Biomarkers in Acute Ischemic Stroke.”



Cerebrovascular Section of the AANS/CNS – EC meeting update 10/20/2019



We would like to acknowledge and thank the following reviewers:

Dandan Sun, MD, PhD
Professor of Neurology
University of Pittsburgh

G. Edward Vates, MD, PhD
Professor of Neurosurgery, Endocrinology
& Otolaryngology
University of Rochester Medical Center

Robert Friedlander, MD, MA
Chair, Walter E. Dandy Professor of Neurosurgery,
Neurology & Neurobiology
University of Pittsburgh

Mustafa Baskaya, MD
Professor of Neurological Surgery
University of Wisconsin – Madison

Robert Dempsey, MD
Chair & Manucher Javid Professor of
Neurological Surgery
University of Wisconsin – Madison



Cerebrovascular Section of the AANS/CNS – EC meeting update 10/20/2019



The above slide was reviewed

The above slide was reviewed

CV Section C. Getch Research Award

Dr. David

-No Report

No report



Cerebrovascular Section of the AANS/CNS – EC meeting update 10/20/2019



Adam Arthur: This is an award for a board certified neurosurgeon to go for a week anywhere they want. We are not seeing a ton of applications, so it's really easy to apply and have a chance to win. The intention is for the section to serve our membership, so we wanted to have something specifically for someone who is board certified. For the moment this is only a domestic award.

CV Traveling Fellowships

Dr. Adam Arthur

Dr. Clemens Schirmer

-Verbal Report



Cerebrovascular Section of the AANS/CNS – EC meeting update 10/20/2019



Dacey Medal

Dr. Zipfel

-No Report

JM: the winner has been decided, but I'm not sure if it's been shared yet



Cerebrovascular Section of the AANS/CNS – EC meeting update 10/20/2019





Philanthropy (formerly NREF)

Dr. Kevin Cockroft Reported

Philanthropy

Establish a culture of giving within the CV Section.
Consider a donation to NREF, CNS Foundation or Neurosurgery PAC.

Cerebrovascular Section of the AANS/CNS – EC meeting update 10/20/2019



NREF

L. Nelson “Nick” Hopkins NREF Young Clinician Investigator Award jointly sponsored by Arvind Ahuja and the CV Section.

Kate Carney Memorial AVM Research Award

Traveling Fellowship Award

Honor Your Mentor Funds (Dacey, Drake, Harbaugh, etc.)



Cerebrovascular Section of the AANS/CNS – EC meeting update 10/20/2019



CNS Foundation

Consider a donation to CNS Foundation

1. CNS Foundation General Fund
2. Fellowship Training Awards & Grants Fund
3. Guidelines Development Fund
4. Leadership in Healthcare Fund
5. NINDS/CNS Getch Scholar K12 Award

<https://www.cns.org/about-us/foundation/donate>



Cerebrovascular Section of the AANS/CNS – EC meeting update 10/20/2019



Neurosurgery PAC

Mission to support candidates for federal office who support neurosurgeons.

Makes direct campaign contributions to candidates for the U.S. Senate and the U.S. House of Representatives who are supportive of the issues important to neurosurgery.

Nonpartisan and does not base its decisions on party affiliation but instead focuses on the voting records and campaign pledges of the candidates.

<https://myaans.aans.org/MyAANS/DonationPAC.aspx>



Cerebrovascular Section of the AANS/CNS – EC meeting update 10/20/2019



Philanthropy

Section Philanthropy (2017-2018):

100% (8 of 8) of CV Officers gave to CNS Foundation, NREF or NS PAC

Of the 32 members at the EC meeting held during the AANS, 25 members gave to CNS Foundation, NREF or NS PAC



Cerebrovascular Section of the AANS/CNS – EC meeting update 10/20/2019



CNS Education

Dr. Nicholas Bambakidis

-No Report



Cerebrovascular Section of the AANS/CNS – EC meeting update 10/20/2019





Congress of
Neurological
Surgeons

Intersocietal Accreditation Commission - Carotid Stenting

COCKROFT & PATEL

IAC - Carotid Stenting

Four accredited facilities.

- Three fully accredited for three years each.
- 1 received a 1 year provisional grant and has not provided corrective action plan yet to acquire the full granted accreditation.

One delayed application.

- delayed due to significant issues related to neuro testing pre and post CAS and follow up exams with duplex ultrasound and neuro testing.
- No corrective action plan submitted as yet.

One facility's accreditation expired April 30, 2018 and did not submit an application for reaccreditation.

Cockroft elected as Officer-at-Large for division board and Carotid Stenting Division representative to overall IAC board of directors.



Cerebrovascular Section of the AANS/CNS - EC meeting update 10/20/2019



IAC - Carotid Stenting

Four accredited facilities.

Three applications for reaccreditation in 2018

- One was granted as they had no discrepancies.
- One received a one year provisional grant and they were requested to submit their corrective action plans related to the neurological testing (mRS and NIHSS) pre and post carotid stent procedure and a follow up examination with duplex ultrasound and neurological testing (mRS and NIHSS.)
- Accreditation was delayed in one. Facility did not have a quality improvement process. They also did not perform neurologic testing (mRS and NIHSS) pre and post carotid stent procedure and did not perform follow up examinations with duplex ultrasound.



Cerebrovascular Section of the AANS/CNS - EC meeting update 10/20/2019





American Association of Neurological Surgeons



Congress of Neurological Surgeons

Cerebrovascular Coalition

COCKROFT & AMIN-HANJANI

Cerebrovascular Coalition (CVC)

Josh Hirsch is current chair (ASNR).

No recent issues to report.

American Association of Neurological Surgeons

Cerebrovascular Section of the AANS/CNS – EC meeting update 10/20/2019



Brain Attack Coalition

Dr. Judy Huang

-No Report

American Association of Neurological Surgeons

Cerebrovascular Section of the AANS/CNS – EC meeting update 10/20/2019



JC Technical Advisory Pane update

Latest TAP call:

- Continued support for individual physician volume requirements (15/year)
- Continued suspension of CAST training requirements
- Subcommittee formed to explore TSC certification for underserved areas who may not be able to meet current volume requirements for mechanical thrombectomy
- Subcommittee formed to discuss neurocritical care coverage in TSCs and CSCs. Begin with survey to assess neurocritical care coverage in TSCs and CSCs

American Association of Neurological Surgeons

Cerebrovascular Section of the AANS/CNS – EC meeting update 10/20/2019



J Mocco: JC would like to get rid of these requirements, but for now the requirements remain stable. CAST is extremely threatened, but the JC is really struggling with the CAST requirement.

Adnan Siddiqui: They started collecting data this summer, if you look at the data, I think we need to make sure

J Mocco: The AHA did push to the New York body to try to push to be the sole provider. The next stage will be what do we do with those already in practice.



CAST Update

ADNAN SIDDIQUI

A lot's been happening on the CAST front. There's a transition going on from CAST to the ABMS.

Transition from CAST only to ABMS and CAST process

Initiation 2019



Cerebrovascular Section of the AANS/CNS – EC meeting update 10/20/2019



The Recognized Focused Practice (RFP) in CNS Neuroendovascular Surgery

This RFP is co-sponsored by the American Board of Neurological Surgery, American Board of Radiology, and the American Board of Psychiatry and Neurology. The ABNS will serve as the managing ABMS board. This RFP has been approved by the ABMS and has the goal of recognizing candidates who have successfully completed standardized neuroendovascular training and practice criteria, thereby elevating and advancing patient care for the public good.

Individual certification will go through the ABMS, however, institutional will continue to be under CAST



Cerebrovascular Section of the AANS/CNS – EC meeting update 10/20/2019



Organizational Structure:

There will be two committees, NESAC (**N**euro-**E**ndovascular **S**urgery **A**dvisory **C**ommittee) and CESAC (**C**redentialing **E**ndovascular **S**urgery **A**dvisory **C**ommittee), that will work collaboratively in the work of fellowship **accreditation** (NESAC) and fellow **credentialing** (CESAC). Once established, they will work independently to accomplish their charges. Membership of each committee will consist of equal numbers of representatives from neurological surgery, neuroradiology, and neurology. The chair of NESAC will be selected by SNS-CAST. The CESAC Chair may be from any of the 3 disciplines, and CESAC will consist of equal representation of the 3 parent organizations, the ABR, ABPN, and ABNS. The chairs will be responsible for providing timely reports back to the parent organizations and for coordinating the timing of and agenda for meetings between the parent organizations and the committee members. NESAC and CESAC will be self-governed with the oversight and approval of their parent organizations.

The committee who oversaw cast was NESAC, however under the ABMS it's going to have a different name



Cerebrovascular Section of the AANS/CNS – EC meeting update 10/20/2019



ABMS has accepted the responsibility of ABNS

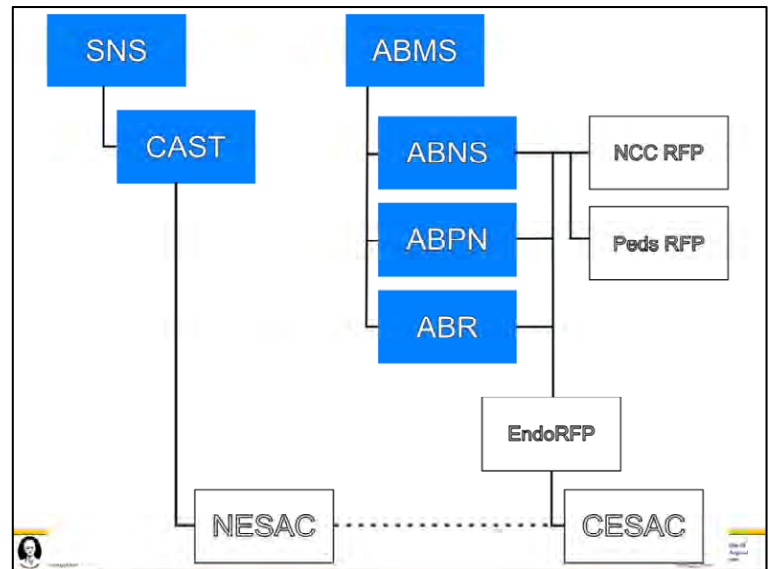

NESAC Membership

Neurosurgery JSCVS - Joint Section: Cerebrovascular Surgery (AANS/CNS)

Name	Institution	Term Start	Term End
Brian Hoh, MD**	University of Florida-Gainesville	2015	2020
Adnan Siddiqui, MD	SUNY Buffalo	2015	2019
Howard Rina, MD	New York University	2015	2018

Neurology SVIN – Society of Vascular and Interventional Neurology

Name	Institution	Term Start	Term End
Tudor Jovin, MD**	University of Pittsburgh	2015	2020
Saim Zaidat, MD	Medical College of Wisconsin	2015	2019
Raio Linfante, MD	Miami, FL	2015	2018

Radiology SNIS – Society of Neurointerventional Surgery

Name	Institution	Term Start	Term End
Philip Meyers, MD**	Columbia University	2015	2020
Colin Derdeyn, MD	Washington University at St. Louis	2015	2019
Aquila Turk, MD	Medical University of South Carolina	2015	2018

** denotes signing member of NESAC formation document, finalized Jan 2015

Currently we have these 3 members



Cerebrovascular Section of the AANS/CNS – EC meeting update 10/20/2019



I. NESAC Membership

Name	Institution	Term Start	Term End
Howard Riina MD	New York University	2015	2018
Adam Arthur MD	UT Memphis	2018	2021

Name	Institution	Term Start	Term End
Italo Linfante, MD	Miami, FL	2015	2018
Johanna Fifi MD	Mt. Sinai NYC	2018	2021

Name	Institution	Term Start	Term End
Aquilla Turk, MD	USC Greenville SC	2015	2018
Lee Pride MD	UT Southwestern	2018	2021

Instead of anyone retiring, we added on to the committee



Cerebrovascular Section of the AANS/CNS - EC meeting update

CNS endovascular surgery Advisory Committee (CESAC)

ABNS

Adam Arthur
Bernard Bendok
Sander Connolly
Brian Hoh
Louis Kim
Elad Levy
Howard Riina
Adnan Siddiqui
Erol Veznedaroglu

ABR

Colin Derdeyn
Vince Matthews
Phil Meyers
Aquilla Turk
Dave Fiorella
Sameer Ansari
Lee Pride

ABPN

Lucas Elijevich
Johanna Fifi
Tudor Jovin
Italo Linfante
Sandra Narayanan
Dileep Yavagal
Osama Zaidat
Larry Faulkner

Non-voting Advisors

Fred Meyer ABNS Exec Director
Valerie Jackson ABR Exec Director
Nick Barbaro Chair CAST SNS



Cerebrovascular Section of the AANS/CNS - EC meeting update 10/20/2019



Fellowship Accreditation: NESAC

Accreditation of fellowships will be done by NESAC under the authority of the Society of Neurological Surgeons through its Committee for Advanced Subspecialty Training (CAST). This committee will establish fellowship educational and training requirements based on agreed upon criteria which will include procedural case volumes available for training fellows, faculty experience, facilities, academic environment, and institutional/departmental support. The NESAC committee will use these criteria to approve fellowship applications from all specialties.



Cerebrovascular Section of the AANS/CNS - EC meeting update 10/20/2019



Fellow Credentialing: CESAC

Credentialing of fellows trained in CAST (NESAC) accredited and ACGME fellowships will be done by a committee termed CESAC. This committee will consist of all NESAC members as well as appointees from the ABNS, ABPN, and ABR, with an equal number of experts from all three specialties. CESAC is charged with: 1) writing the cognitive exam (ABNS will refer to this exam as the RFP Endovascular exam), 2) writing an annual adaptive learning tool module to be given in conjunction with member board continuous certification exercises, 3) determining the details of the required practice data submission (both initial and annual) and the metrics by which that data is approved or denied, and 4) recommending approval for initial RFP in CNS Neuroendovascular Surgery by their respective Boards. Although the ABNS will serve as the managing board, RFP Certificates will be issued and maintained by the appropriate ABMS member Board.



Cerebrovascular Section of the AANS/CNS – EC meeting update 10/20/2019



Endovascular Pathway for Neurosurgeons

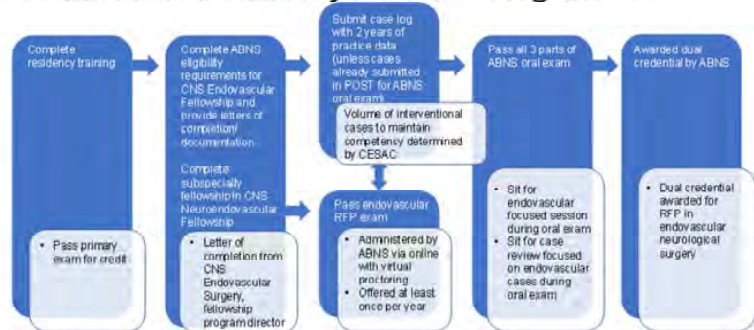

Cerebrovascular Section of the AANS/CNS – EC meeting update 10/20/2019



Endovascular Pathway for Neurologists

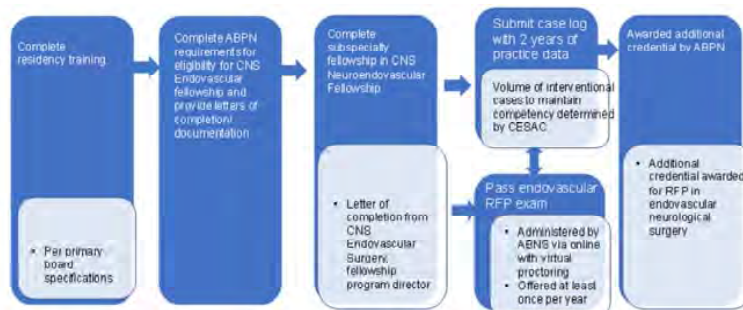

Cerebrovascular Section of the AANS/CNS – EC meeting update 10/20/2019



Endovascular Pathway for Radiologists

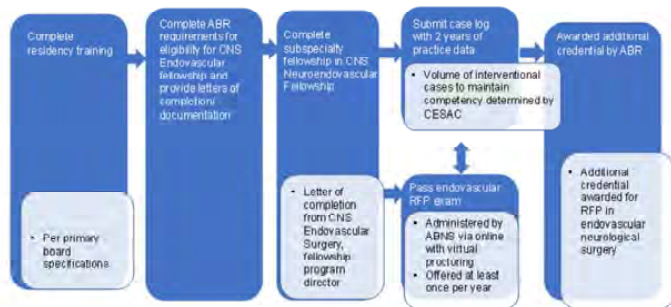

Cerebrovascular Section of the AANS/CNS – EC meeting update 10/20/2019



This also continues, the difference is cast will no longer provide certificates to those who go through the grandfathering process.

Practice Track Application Pathway

Current neuroendovascular physicians are eligible to achieve RFP credentialing through this practice track regardless of whether they trained in a CAST, ACGME or another type of program by completion of the following steps:

- 1) CESAC review of fellowship training or equivalent clinical experience
- 2) Two consecutive years of practice data after the fellowship will be need to be submitted in an Excel spreadsheet or equivalent to CESAC. Cases may be selected to be entered into ABNS Post for peer review.
- 3) Passing the RFP CNS Endovascular written examination
- 4) Licensing and credentials review
- 5) Two peer letters of recommendation attesting to the candidates' endovascular qualifications
- 6) Participation in annual Continuing Certification (learning tool, entry of 65 cases annually into online database)

Current neuroendovascular physicians who are already CAST certified and whose credentials have been forwarded to their respective ABMS boards for RFP can maintain their status by participation in annual Continuing Certification (learning tool, entry of 65 cases annually into online database), and all other requirements of this process going forward.

Continuing Certification for CNS Endovascular Surgery:

- 1) Maintain Primary Board Certification through ABNS, ABPN or ABR
- 2) Proof of Unencumbered certification(s)
- 3) Proof of Unencumbered state license(s)
- 4) Proof of Unencumbered staff privileges in each hospital at which the applicant practices
- 5) Documentation of full participating in MOC/CC per the requirements of primary (and secondary) board(s)
- 6) Cases may be selected to be entered into ABNS Post for peer review. Participants should demonstrate that their practice is actively FOCUSED, by submitting streamlined evidence (patient identifier, date of service and CPT code) that they performed 65 endovascular cases (including angiograms) for the 12 month period in question. The ABNS will audit 1% of participants. The ABNS will provide an online templated form to support this collection which will take minimal time for completion.
- 7) Complete the annual CNS-ES learning tool/ RFP specific module offered via ABNS (on-line)
- 8) There will be a one-year grace period for completion of these requirements without revocation or suspension of the RFP, with potential diplomate review by CESAC.

There are no additional fees to those who have completed the process Those who are currently fellows will have to sit for a written exam.



Cerebrovascular Section of the AANS/CNS – EC meeting update 10/20/2019



Neuroendovascular surgery Certificate for Recognized Focused Practice (RFP) - September 2019

Approved
• Under review

320
74

Those under review will be judged at the end of November.

CAST Individual Certifications NeuroEndovascular Surgery (NES) (as of April 2019)



Certificates:

Approved

- a. Neurosurgeons 119
- b. Neurologists 85
- c. Radiologists 105

TOTAL 309

total after CAST approval at April AANS meeting

These fellowships are currently approved for training. There's a discussion on whether we should go above ACGME programs.

Adnan Siddiqui: It is not NESAC, it is CESAC. The boards are determining who should be able to get individual certification.

J Mocco: The JC is anxiously awaiting the resolution of this discussion

Sepideh Amin-Hanjani: For folks who are not ABNS certified because they trained foreign, what happens to them?

Adnan Siddiqui: This is a discussion happening at the level of ABNS, there are ABNS boards who allow foreign trained physicians to obtain board certification, but it's just a proposal, there's nothing forthcoming. There's no desire on the part of ABNS to make all Canadians eligible. This is not going to be something that just anyone can become eligible for.

Type	Program
Endovascular Neurosurgery	Abbott Medical Center
Endovascular Neurosurgery	Barrow Neurological Institute
Endovascular Neurosurgery	Baylor College of Medicine
Endovascular Neurosurgery	Brigham and Women's Hospital/Boston Chi
Endovascular Neurosurgery	Cedars-Sinai Medical Center
Endovascular Neurosurgery	Columbia University Physicians & Surgeons
Endovascular Neurosurgery	Department of Neurosurgery Residency Pa
Endovascular Neurosurgery	Department of Neurosurgery Residency Pa
Endovascular Neurosurgery	Emory University School of Medicine
Endovascular Neurosurgery	Geisinger
Endovascular Neurosurgery	Goldman-Cardinal Ryan and Same
Endovascular Neurosurgery	Henry Ford Hospital
Endovascular Neurosurgery	Georgetown School of Medicine at Mount Sinai
Endovascular Neurosurgery	Johns Hopkins School of Medicine
Endovascular Neurosurgery	Massachusetts General Hospital
Endovascular Neurosurgery	Medical College of Georgia at Augusta U
Endovascular Neurosurgery	Medical University of South Carolina
Endovascular Neurosurgery	Neurological Surgery, Northwestern Univ
Endovascular Neurosurgery	Neurosurgery Residency of the Universit
Endovascular Neurosurgery	Rush Neurosurgery
Endovascular Neurosurgery	Rush University Medical Center
Endovascular Neurosurgery	SLUW BOSTON DEPT OF NEUROLOGY/UCSF
Endovascular Neurosurgery	Stanford Neurosurgery
Endovascular Neurosurgery	State University of New York at Buffalo
Endovascular Neurosurgery	The Ohio State University Medical Center
Endovascular Neurosurgery	Thomas Jefferson University hospital
Endovascular Neurosurgery	UCLA Dept of Neurosurgery
Endovascular Neurosurgery	UT Southwestern Department of Neurosurg
Endovascular Neurosurgery	UW Madison Department of Neurological S
Endovascular Neurosurgery	University Hospitals Cleveland Medical
Endovascular Neurosurgery	University of Alabama at Birmingham
Endovascular Neurosurgery	University of California San Diego
Endovascular Neurosurgery	University of Cincinnati
Endovascular Neurosurgery	University of Florida
Endovascular Neurosurgery	University of Iowa Hospitals and Clinic
Endovascular Neurosurgery	University of Miami/Jackson Health Syst
Endovascular Neurosurgery	University of Michigan
Endovascular Neurosurgery	University of Pittsburgh Department of
Endovascular Neurosurgery	University of Southern California
Endovascular Neurosurgery	University of Texas Health Science Cent
Endovascular Neurosurgery	University of Utah
Endovascular Neurosurgery	University of Virginia Department of Ne
Endovascular Neurosurgery	University of Washington
Endovascular Neurosurgery	University of Wisconsin Hospitals and C
Endovascular Neurosurgery	Yonkers University Medical Center Din
Endovascular Neurosurgery	Yonkers University Medical Center Din
Endovascular Neurosurgery	Wake Forest School of Medicine
Endovascular Neurosurgery	Westchester Medical Center/ NY Medical

Neuroendovascular surgery Approved Fellowship Programs September 2019

Approved 49



Cerebrovascular Section of the AANS/CNS - EC meeting update 10/20/2019

Rapid Response Committee

Dr. Henry Woo
Dr. J Mocco
Dr. Alex Khalessi

No Report

American Association of Neurological Surgeons Cerebrovascular Section of the AANS/CNS – EC meeting update 10/20/2019 University of Colorado

Updates

MOU signed and NVQI-QOD combined under SNIS PSO

New database managed by m2S – Runs VQI

Ongoing contracting – change focus from individuals and practices to hospital based management

Ongoing discussions with SVIN with proposed MOU under review

Contracting between Cornell Data center and industry partners as well as NVQI QOD and GW TG to perform first data project to assess value of basilar thrombectomy

American Association of Neurological Surgeons Cerebrovascular Section of the AANS/CNS – EC meeting update 10/20/2019 University of Colorado

There is an MOU under SVIN to create one registry. I expect some re-branding once these are in place. There's a real push to switch from contracting by department to hospital based contracting.

Coding & Reimbursement Committee

Dr. Clemens Schirmer
Dr. Henry Woo

American Association of Neurological Surgeons Cerebrovascular Section of the AANS/CNS – EC meeting update 10/20/2019 University of Colorado

We convinced them to not look at the codes for the next few years

Rapid Response Committee

Dr. Henry Woo
Dr. J Mocco
Dr. Alex Khalessi

No Report

American Association of Neurological Surgeons Cerebrovascular Section of the AANS/CNS – EC meeting update 10/20/2019 University of Colorado

QOD

Dr. Connolly
Dr. Mocco

-No Report

JGC/CV Section Guidelines Committee

Babu G. Welch, (Chair)

-Verbal Report

MOC/Vascular Update

Dr. Adnan Siddiqui

No
Report

Babu Welch: The whole morning today was guidelines, what's going on now is the acute stroke guidelines are still under review. We're going to come up with a final plan, we're waiting on a response from the AHA. There's a discussion about aspiration, one of the big sticking points is their encouraging individual centers to credential stroke, there's nothing that refers to a specific credentialing criteria. Right now it's imminent on whether or not we'll endorse this. The stroke systems of care update suggested that something like cast be used or grown. The concern is how far along they are in the whole process. There's another few guidelines on non-neurological procedures, but that's still under review. All of the members of the guidelines committee are maintaining their roles.



Report Presented by Dr. Adam Arthur

Bill Mack: Thanks Adam for this report

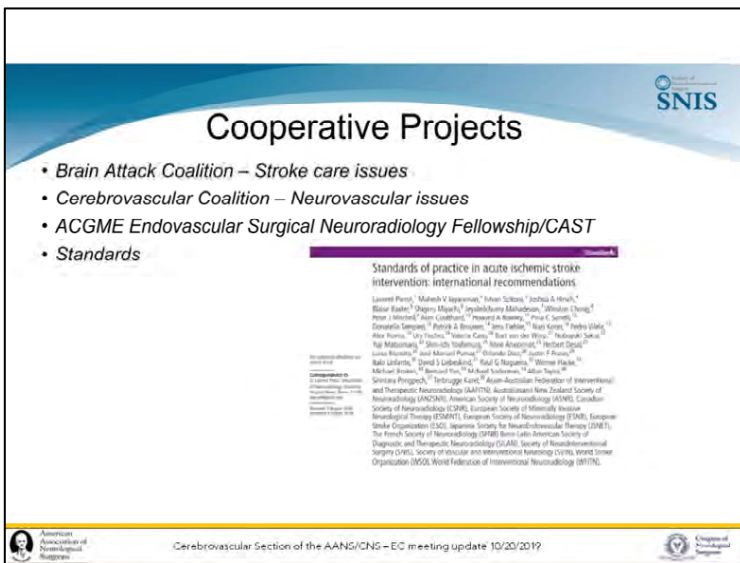

The above are things we're focused on



get ahead of
STROKE
Improving systems of care

- Launched in May 2016
- Campaign is focused on organizing stronger stroke systems of care nationwide.
- Goal is to enact legislative change in all 50 states requiring EMS to take ischemic stroke patients with large vessel occlusion to neurointerventional-ready hospitals with 24/7/365 coverage.

American Association of Neurological Surgeons Cerebrovascular Section of the AANS/CNS – EC meeting update 10/20/2019 University of Washington

A lot of effort has been put into the above



Meetings

AANS/CNS Joint CV Section Annual Meeting
February 4-5, 2019
Honolulu, HI

413 Attendees



AANS/CNS Joint Cerebrovascular Section ANNUAL MEETING
Programming in conjunction with SVIS

SNIS 16th Annual Meeting
July 22-25, 2019
Miami, FL

1068 Attendees

American Association of Neurological Surgeons Cerebrovascular Section of the AANS/CNS – EC meeting update 10/20/2019 University of Washington

These were two very recently successful meetings. With all of this work on the meetings being combined at the summertime SNIS annual meeting, I think this is an awesome opportunity; it's going to be a good forum for the CV group to get together. Getting everyone on the same page will strengthen our position. We have an MOU for three years, this will be a great barometer on how this will work.

Adam Arthur: The SNIS Meeting is about 3 times as large as the CV Section Meeting. If we show up how we did last year, it will be a far bigger meeting than any other year.

Bill Mack: the better the meeting, the better the CV section benefits. The best thing for this group is to get people there.

Question from the audience: How big is SVIN?

Adam Arthur: Their meeting is in a few weeks in Atlanta, I think it's between the two meetings.





Publications - Journal Update

Initial publication July 2009 as a quarterly journal
Indexed in Thomson-Reuters 2010
2018 Impact factor 3.925
Pub Med/Medline indexing September 2011

Editor-in-Chief, Felipe C. Albuquerque, MD



We have a lot of representation on the Journal



Societal Converging Goals

- *Pay for performance evaluation and issues*
- *Medicare reductions in payment*
- *Standards of practice – stroke, carotids, aneurysms*
- *Defining the appropriate randomized trials*
- *Coding*
- *“Comprehensive Stroke Center” designation*
- *Refining standards of training in Endovascular (CAST)*
- *Generating resident interest in Neurovascular*





SNIS Update Summary

Healthy membership growth of this multi-disciplinary society

Continued involvement with CV Section

Membership is growing, I encourage even those who aren't endovascular surgeons to join this society.

Bill Mack: I mention in the newsletter that there's funding from the companies who previously used to fund the meeting, that funding has been diverted to a combined CV/SNIS fund

Stavropoula Tjoumakaris: Is it possible to have a joint membership for those who are interested in both, with some discount?

Adam Arthur: That is something we've talked about, when the SNIS board talked about that, the decision was made to hold off on that for the future. It's not so much the discount, but we need to be a louder voice in SNIS.

SVIN Update

No Report



Cerebrovascular Section of the AANS/CNS – EC meeting update 10/20/2019

The above slide was reviewed

International liaison – Mika Niemelä

-Helsinki 6-month sponsored Research & Observer Fellowship for American residents July 2020-

-ESMINT & EANS vascular Sept 9-11, 2020

-More integration of ESMINT & EANS lectures

-More AANS & CNS CV section representatives

- 10 speakers
- 10 moderators



Cerebrovascular Section of the AANS/CNS – EC meeting update 10/20/2019



Newsletter Committee

Dr. Ducruet

-Verbal Report

Newsletter went out a few days ago, no real updates other than we talked about me transitioning off the committee



Cerebrovascular Section of the AANS/CNS – EC meeting update 10/20/2019

YNS Liasion

Dr. Brian Howard

-No Report



Cerebrovascular Section of the AANS/CNS – EC meeting update 10/20/2019



Resident & Fellow Courses

Dr. Kellner
Dr. Binning
Dr. Arthur
Dr. Mascitelli



Cerebrovascular Section of the AANS/CNS – EC meeting up

Resident and Fellows Courses

Fellows Course in Endovascular Techniques

Course Director(s): Adam S. Arthur, MD, MPH, FAANS; Erol Veznedaroglu, MD, FAANS; and Alex Berenstein, MD
Date(s): Sept 27-29, 2019
Location: Memphis, TN

Endovascular and Vascular Techniques for Residents

Course Director(s): Adam S. Arthur, MD, MPH, FAANS; Michael T. Lawton, MD, FAANS; and Erol Veznedaroglu, MD, FAANS
Date(s): Nov 8-10, 2019
Location: Memphis, TN

AANS Cerebrovascular Resident Course

Course Director(s): Mandy Binning, MD; Justin Mascitelli, MD; and Chris Kellner, MD
Date(s): April 25th, 2019
Location: Boston, MA



Cerebrovascular Section of the AANS/CNS – EC meeting update 10/20/2019



The fellows course has new course directors, all new course directors are noted above. The courses are continuing, if you are interested in being faculty for these courses, I caution you that it's a full meeting, but please say something to me (AA), or someone else

Resident and Fellows Courses

Email: Justin Mascitelli jmascite@gmail.com
to add courses or meetings to the site.



Cerebrovascular Section of the AANS/CNS – EC meeting update 10/20/2019



Active updating of the website about these courses



American Association of Neurological Surgeons



Congress of Neurological Surgeons

3C Update

ADNAN SIDDIQUI



3C in the Village
Cottonwood Ballroom at the Four Seasons

TETON VILLAGE, WY



SAVE THE DATE!

13TH ANNUAL
Cerebrovascular Complications Conference (3C)

June 28–July 1, 2020

Save the date for this meeting designed to meet the complex educational needs of physicians from diverse backgrounds through a no-holds-barred sharing of our worst complications, focusing on how the disaster occurred and how you might prevent it in the future. The exchange of ideas among physicians, scientists, and other health care professionals will be facilitated and encouraged in a confidential environment through a format of case discussions and candid debates.

Conference information will be available soon at our website, JIMeetings.org. Registration opens in November.

For more conference information, contact:

Courtney Flick

716.888.4805

jimeetings@jacobsinstitute.org

Margie Whistler

716.510.7668

mwhistler@jacobsinstitute.org

Cerebrovascular Section of the AANS/CNS – EC meeting update 10/20/2019



Course Directors

Eric Peterson - U Miami

Max Mokin – U South Florida

Nima Etminan – U Heidelberg



Cerebrovascular Section of the AANS/CNS – EC meeting update 10/20/2019



Strategic Planning

Dr. Welch



Cerebrovascular Section of the AANS/CNS – EC meeting update 10/20/2019



Babu Welch: AANS mentioned the strategic planning piece, after working with them we'll have more to discuss. There's a push from both parent organizations to have more international interaction, but I think there's aspects of this which are challenging. More to come on this in future.

Motion to Adjourn:

Meeting adjourned at 3:00pm